

Ficha Técnica
Linha Standard

PRATIKA - M106

Maçaneta em Zamac

Broca: 40mm

Roseta: em Aço Inox / Aço Carbono

Testa e Contra Testa: material usado de acordo com o acabamento

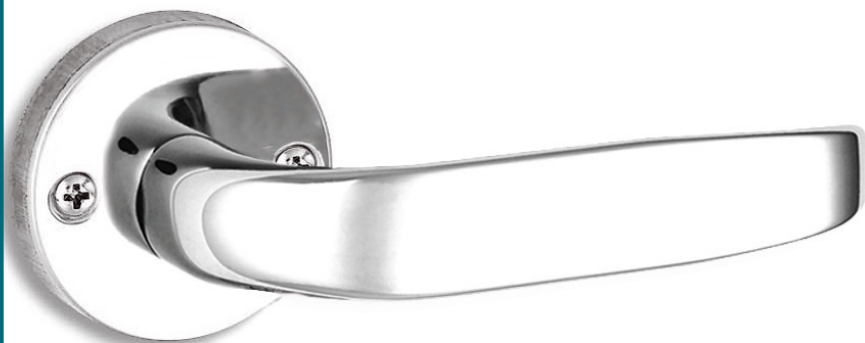

Aplicação

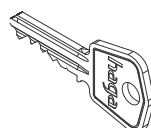

Ext.

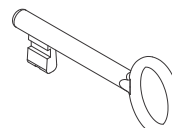

Int.

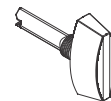

WC



Maçaneta:

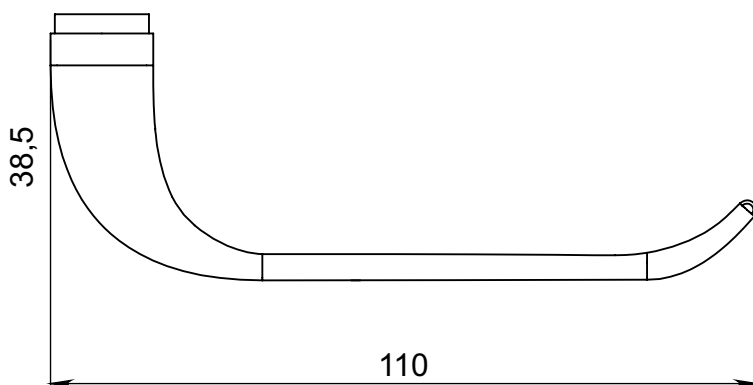

Acabamentos:



Cr
Cromado



CrA
Cromo
Acetinado

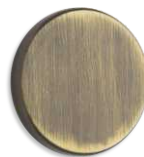

OXI
Oxidado



RP
Resinado
Preto

Rosetas:

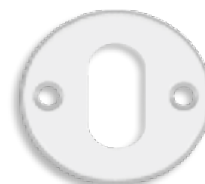

R. 526

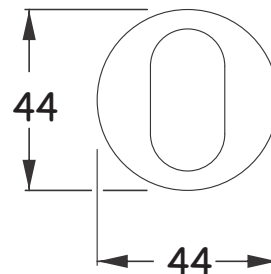

haga | 80+



ASSOCIAÇÃO
BRASILEIRA
DE NORMAS
TÉCNICAS



mais presente - mais futuro - mais seguro

Ficha Técnica

Máquina broca de 40mm

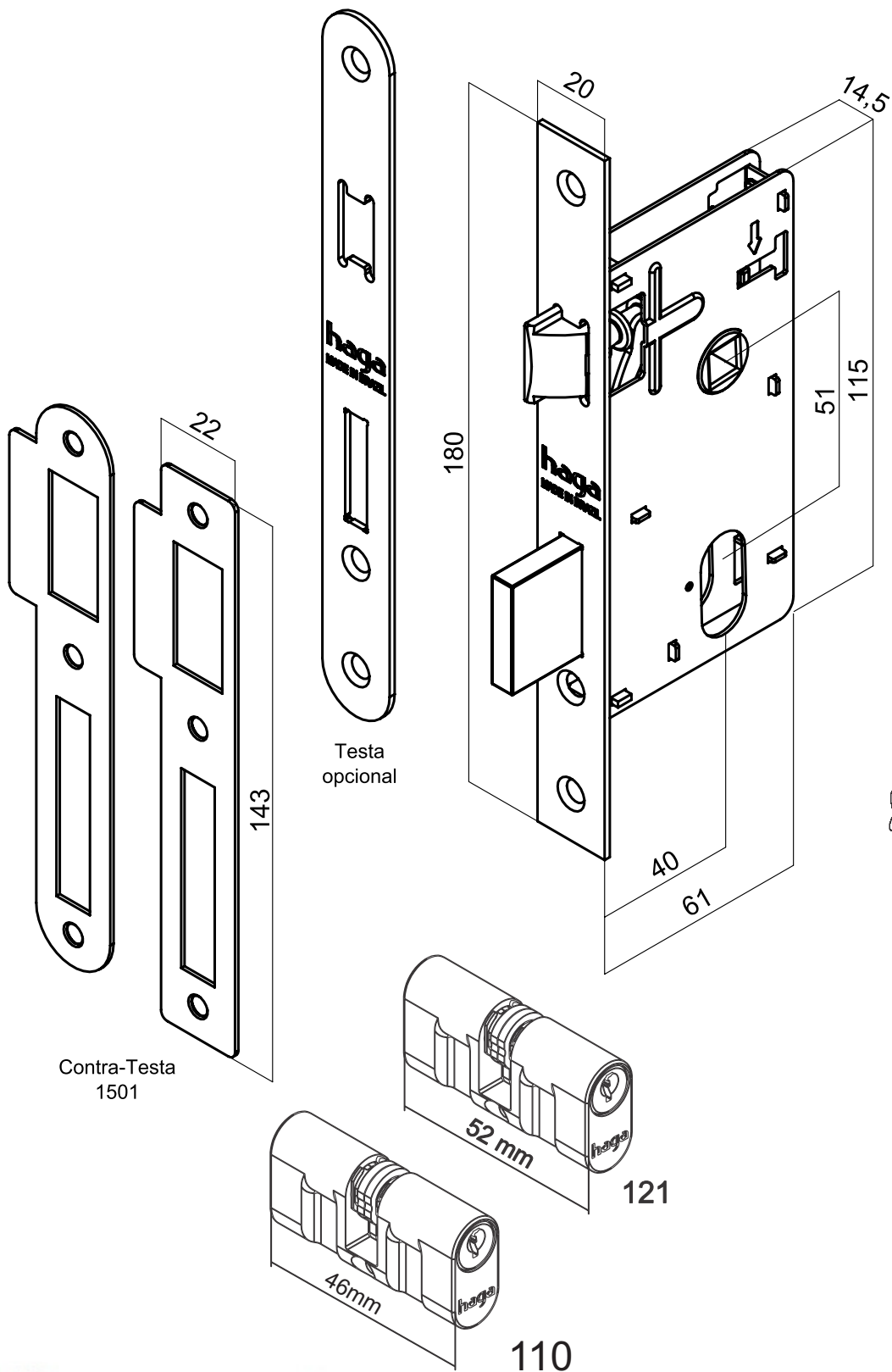

Varição de Segredo: 12.500

Interna

Varição de Segredo: 6

WC



Tráfego: Médio



Resistência a Corrosão: 2



Grau de Segurança: Média

haga | 80+

mais presente - mais futuro - mais seguro