

Ficha Técnica
Linha Standard

TEK - M80

Maçaneta em Zamac

Broca: 40mm

Espelho: em Aço Inox / Aço Carbono

Testa e Contra Testa: material usado de acordo com o acabamento



Aplicação

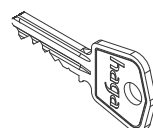

Ext.

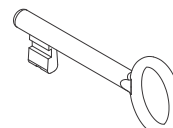

Int.

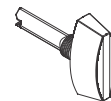

WC

Maçaneta:

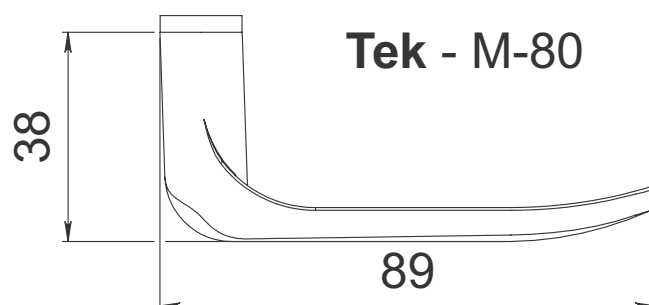
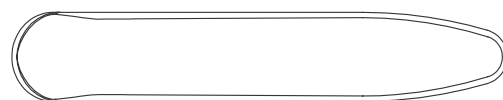

Acabamentos:



Cr
Cromado



OXI
Oxidado

Espelho:



E. 170

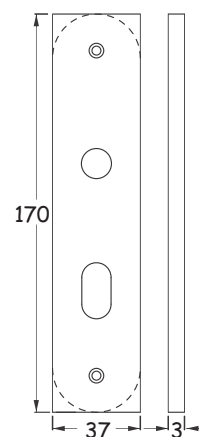

haga | 80+



mais presente - mais futuro - mais seguro

Ficha Técnica

Máquina broca de 40mm

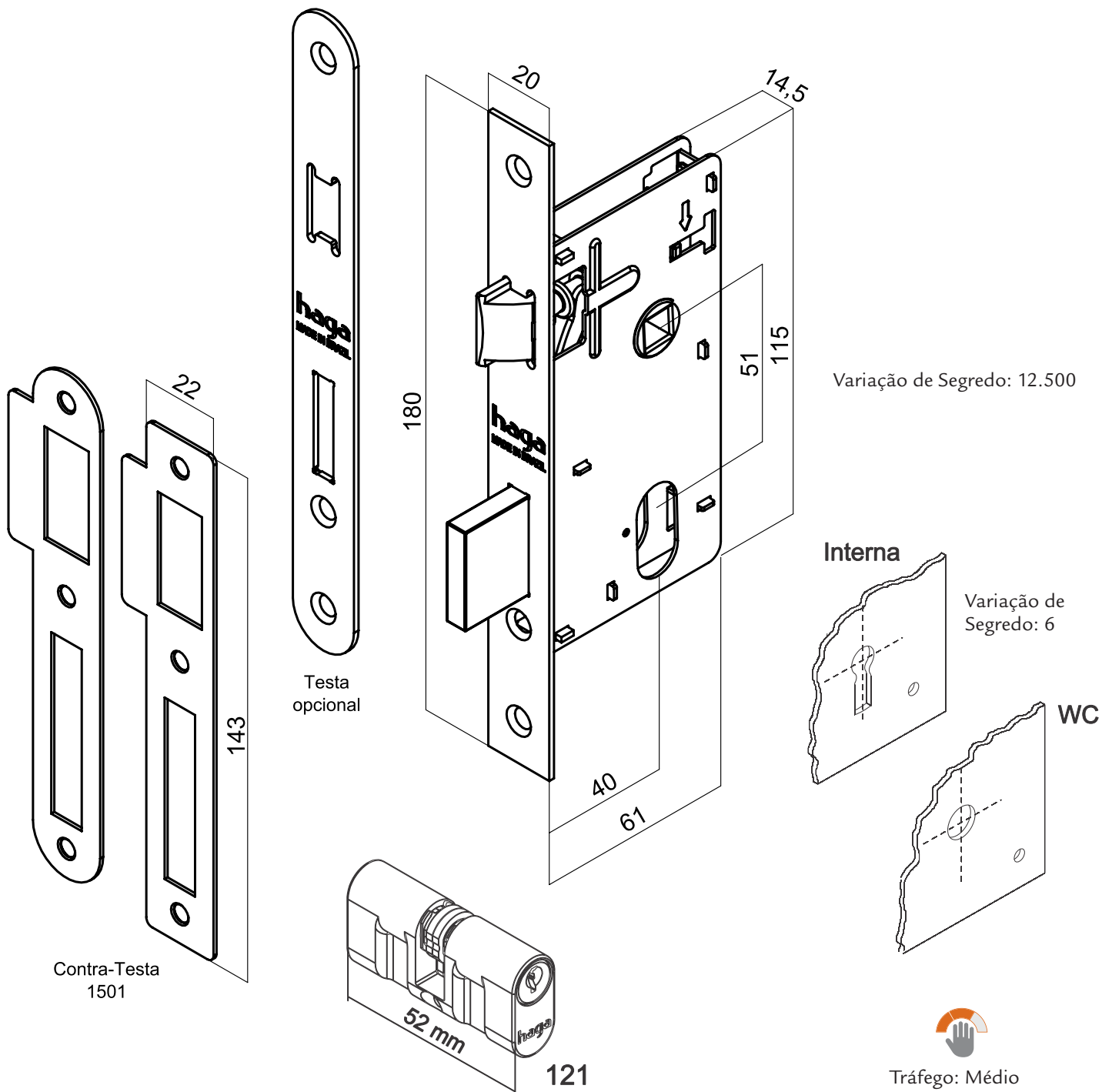

Contra-Testa
1501

Testa
opcional

Varição de Segredo: 12.500

Interna

Varição de
Segredo: 6

WC

121



Tráfego: Médio



Resistência a Corrosão:
2



Grau de Segurança:
Média

haga | 80+

mais presente - mais futuro - mais seguro