

Ficha Técnica

Linha Design

Tub - M133

Maçaneta: em Zamac

Broca: 40mm

Roseta: em Aço Inox

Testa e Contra Testa: material usado de acordo com o acabamento



Aplicação

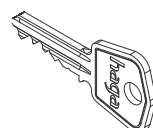

Ext.

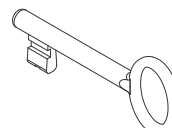

Int.

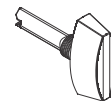

WC

Maçaneta:

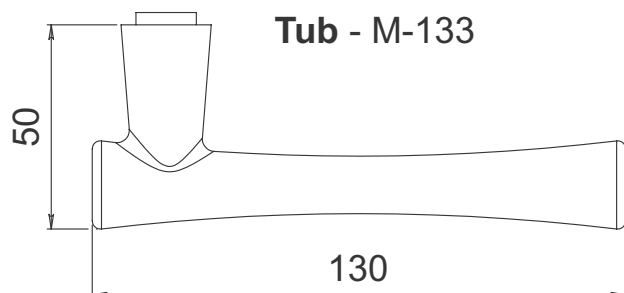
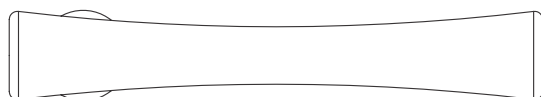

Acabamentos:



IP
Inox Polido



IE
Inox Escovado

Rosetas:



R. 527

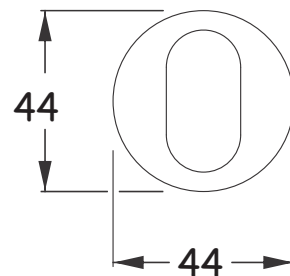

haga | 80+



mais presente - mais futuro - mais seguro

Ficha Técnica

Máquina broca de 40mm

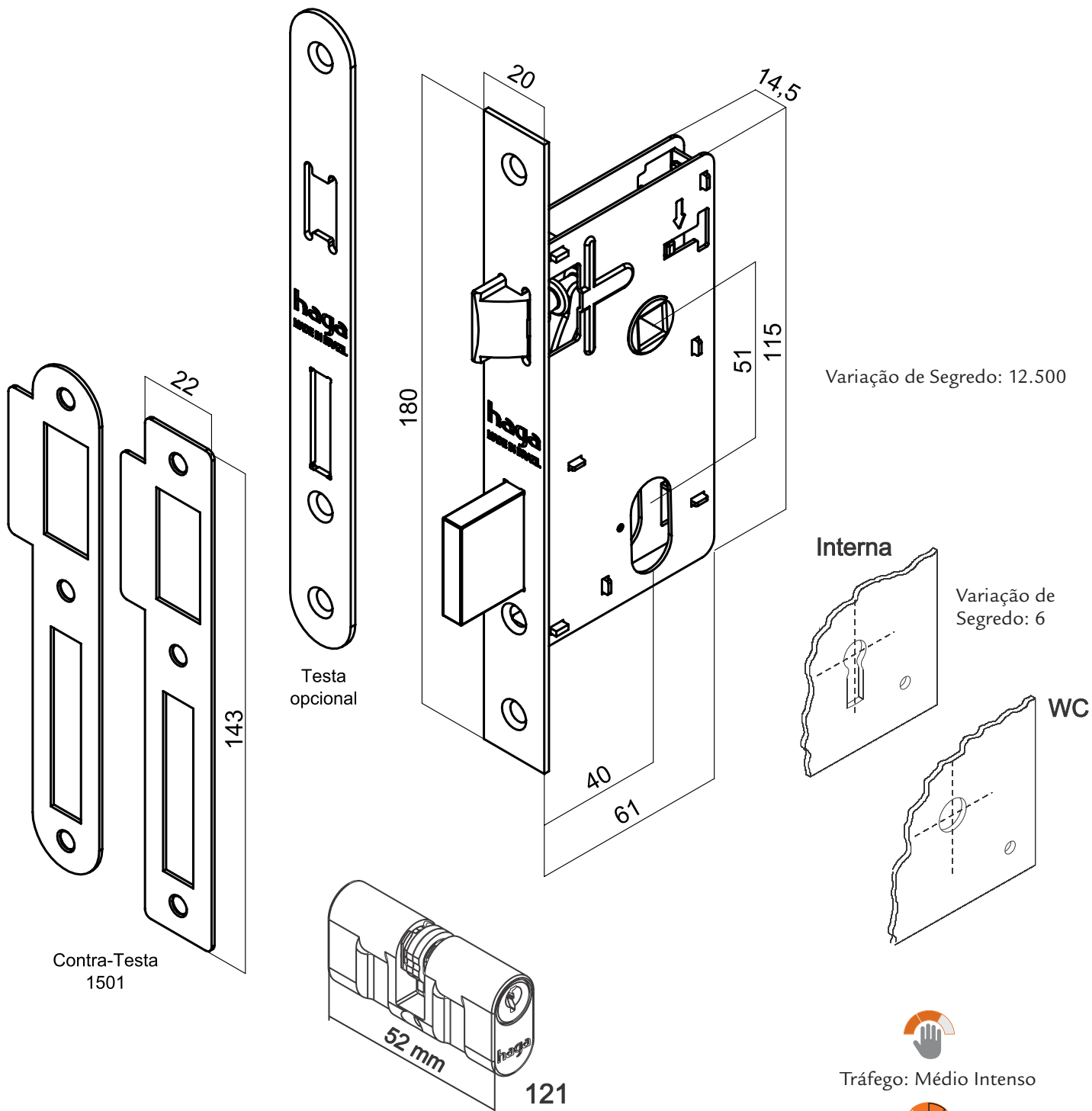

Varição de Segredo: 12.500

Varição de Segredo: 6

Interna

WC

Contra-Testa
1501

Testa
opcional

121



Tráfego: Médio Intenso



Resistência a Corrosão:
4



Grau de Segurança:
Média Alta

haga | 80+

mais presente - mais futuro - mais seguro